

Validation of Replay-Based Underwater Acoustic Communication Channel Simulation

Roald Otnes, *Member, IEEE*, Paul A. van Walree, *Member, IEEE*, and Trond Jenserud

Abstract—This paper discusses validation methods for underwater acoustic communication channel simulators, and validates direct and stochastic replay of underwater acoustic communication channels as implemented in a channel simulator called Mime. Direct replay filters an input signal directly with a measured time-varying impulse response, whereas stochastic replay filters an input signal with a synthetic impulse response consistent with the scattering function of the measured channel. The validation uses data from two sea experiments and a diverse selection of communication schemes. Good agreement is found between bit error rates and packet error rates of *in situ* transmissions and simulated transmissions. Long-term error statistics of *in situ* signaling are also reproduced in simulation when a single channel measurement is used to configure the simulator. In all except one comparison, the packet error rate in simulation is within 20% of the packet error rate measured on location. The implication is that this type of channel simulator can be employed to test new modulation schemes in a realistic fashion without going to sea, except for the initial data collection.

Index Terms—Channel models, computer simulation, multipath channels, time-varying channels, underwater acoustics, underwater communication.

I. INTRODUCTION

UNLIKE radio-frequency communications, whose development is primarily based on channel simulation techniques, acoustic communications still rely on extensive sea trials for validation and testing of communication algorithms. Although the construction of an acoustic channel simulator also depends on sea trials for testing and validation of simulation algorithms, its availability can significantly reduce the cost of future developments in underwater communications. Another advantage of an acoustic channel simulator is the opportunity to define standard channels and test different modulation schemes under identical conditions. For example, this gives the possibility to choose the best communication system for a given case, or the best parameter settings for a given communication system.

Manuscript received November 12, 2012; revised March 27, 2013; accepted May 06, 2013. Date of publication August 08, 2013; date of current version October 09, 2013. This paper was presented in part at the Underwater Acoustics Measurements Conference, Kos, Greece, June 2011 and at the Underwater Communications: Channel Modelling & Simulations Conference, Sestri Levante, Italy, September 2012.

Guest Editor: M. Porter.

The authors are with the Norwegian Defence Research Establishment (FFI), Horten NO-3191, Norway (e-mail: roald.otnes@ffi.no; paul.vanwalree@ffi.no; trond.jenserud@ffi.no).

Color versions of one or more of the figures in this paper are available online at <http://ieeexplore.ieee.org>.

Digital Object Identifier 10.1109/JOE.2013.2262743

A channel simulator for underwater acoustic channels was presented in [1] and later received the name Mime. Its most mature simulation modes use direct or stochastic replay of *in situ* measurements of the time-varying impulse response (TVIR). While [1] presents the channel simulator in detail but only includes a small amount of validation, this paper discusses validation methods and validates the channel simulator with real-world data in two larger validation studies.

Channel simulators can be grouped according to simulation method. The categorization made in [1] is:

- 1) direct replay: reproduce measured channel conditions;
- 2) stochastic replay: generate channel conditions with statistical properties similar to measurement;
- 3) model-based simulation: generate channel conditions by physical modeling based on environmental information.

The meaning of the term “channel conditions” above may vary from simulator to simulator. It often refers to the TVIR, but may also denote noise models and/or more elaborate channel characterization methods.

There exist several approaches to physics-based modeling, including deterministic [2], [3] and stochastic [4], [5] methods as well as methods based on deriving statistical properties from physics [6]. These approaches usually rely on some propagation model to determine, for instance, propagation delay and loss. The most flexible methods for channel modeling are based on direct simulation of time-varying environments [7]. Physics-based models may include the effects of attenuation, noise, multipath, Doppler effects due to platform motion and surface waves [8], as well as effects of bubbles [9]. This paper, however, focuses on replay-based methods.

This paper first discusses methods to validate acoustic channel simulators. A definition of validation is [10], [11] “substantiation that a computerized model within its domain of applicability possesses a satisfactory range of accuracy consistent with the intended application of the model.” Validation can also include identifying the borders of the domain of applicability, to avoid applying the model to cases outside the regime of intended use. This paper focuses on “operational validation,” comparing data from sea experiments and simulation.

The validation uses acoustic measurements from two data sets collected in Norwegian fjord environments. One data set was collected in autumn in the 10–18-kHz frequency band, and the other one in spring in the 4–8-kHz frequency band. The validation addresses direct and stochastic replay, which are simulation methods used in contemporary acoustic channel simulators [1], [12]. Note that validation is included in several papers on underwater acoustic channel simulators (e.g., [1], [6],

and [12]–[14]), where various parameters computed from the simulator output are compared to their corresponding real-world values.

This paper is organized as follows. The channel simulator under examination is briefly described in Section II. Section III discusses validation methods. Sections IV and V present two validation studies, using acoustic data collected during two different sea experiments. These validation studies investigate the reproduction of channel properties as well as the prediction of communication performance. Finally, conclusions are drawn in Section VI.

II. THE MIME CHANNEL SIMULATOR

Mime [1] mimics the acoustic channel by passing the transmit signal through a channel modeled as a TVIR $h(\tau, t)$, where delay τ and time t both are sampled at the sampling rate of the signal. Three simulation modes are included. Mode 1 is direct replay of a measured TVIR, mode 2 is stochastic replay of a measured TVIR, and mode 3 is model-based simulation. The latter mode does not require TVIR measurements, but instead requires environmental data such as sound-speed profiles, wave spectra, etc. Mode 3 is the least mature mode in Mime, but has seen some recent interesting developments [9], [15]. In the remainder of this paper, only replay simulation is considered.

Using direct and stochastic replay, the channel simulator is configured to replay a TVIR obtained from a channel sounding. Channel sounding is done as described in [16]: A pseudonoise probe signal or linear frequency-modulated (LFM) chirp train is transmitted through the underwater acoustic channel. The received signal is passed through a filter matched to the transmit chirp (or m -sequence) to provide a series of impulse response estimates, which are stacked to provide a matrix of complex impulse responses $h(q, n)$, with corresponding time delays $\tau(q) = q/f_s$ and instants $t(n) = nT$. Here, f_s is the sampling rate and T is the repetition period of the probe signal. The value of T represents a crucial tradeoff: The maximum delay spread that can be estimated is given by T , while the maximum Doppler spread that can be estimated is given by $1/T$.

A. Simulation Mode 1: Direct Replay

In direct replay, the channel simulator directly replays the measured TVIR, after resampling to the proper sampling rate in time and delay. In the time domain, the sampling rate of the measurement is the probe repetition rate $1/T$, which is significantly coarser than the desired sampling rate f_s . Although more sophisticated resampling methods have been implemented, the present simulations use one-step linear interpolation as it was sufficient for the encountered channels. The simulation error due to this simple interpolation method is small. A limitation of direct replay is that it is not applicable if the input signal has a longer duration than the probe signal used for the channel sounding.

B. Simulation Mode 2: Stochastic Replay

In stochastic replay, the channel simulator estimates the scattering function $S(\tau, \nu)$ from the measured TVIR, and generates stochastic realizations of the TVIR with the same scattering function. The scattering function is defined as

$$S(\tau, \nu) = E \left[\left| \int_{-\infty}^{\infty} h(\tau, t) e^{-2\pi j \nu t} dt \right|^2 \right] \quad (1)$$

and fully represents the second-order statistics of the TVIR under the assumption of wide sense stationary, uncorrelated scattering (WSSUS). Note that the WSSUS assumption may be violated for real channels. Regarding the uncorrelated scattering (US) assumption, it is remarked that if the tap spacing in delay is finer than what can be resolved by the probe signal, there will always be correlation between neighboring taps even if the physical channel has uncorrelated scatterers. The same applies to wideband propagation effects [17] such as a skewed signal spectrum due to frequency-dependent absorption in the sea. A single physical path in a wideband scenario cannot be represented by a single tap in a tapped delay line. Tap correlation is approximated by an exponential tap cross-correlation function, where the correlation length is estimated from the measured channel [1, Sec. C].

Each time-varying tap is generated by a fading process, where white noise is passed through a filter with response corresponding to the Doppler spectrum of the tap according to (1). Different methods can be selected to estimate the Doppler spectrum of each delay tap: Yule–Walker, Burg, modified covariance, and Welch. All methods can be used to compute finite impulse response (FIR) shaping filters which are the inverse fast Fourier transforms (IFFTs) of the estimated Doppler spectra. The Yule–Walker and Burg methods also give autoregressive (AR) coefficients, which can be directly used as infinite impulse response (IIR) shaping filters.

This study uses IIR noise-generating filters based on Yule–Walker estimation with an AR order of 32. The AR model operates at the repetition period T of the probe signal, and upsampling to the signal sampling rate is done using linear interpolation.

In terrestrial wireless communications, a line-of-sight path is often called a specular path. A key property of such a path is that its amplitude and phase are constant on the time scale relevant to the communication system. In underwater acoustic channels, specular arrivals may occur in the form of direct paths, bottom reflections, and reflections from other static objects such as quay walls, rocks, and ice covers. Any specular (nonfading) components of the channel impulse response are removed before estimation of the scattering function, and reinserted at the output of the fading processes. This significantly improves the reproduction of the Doppler spectrum for channels with a mixture of specular and nonspecular propagation paths. The specular components are here simply defined as the time average $\bar{h}(\tau) = E_t[h(\tau, t)]$ of the measured complex impulse response. This implies that as far as the specular components of the impulse response are concerned, stochastic replay is identical to direct replay.

TABLE I
OUTPUT PROPERTIES USED FOR VALIDATION IN SELECTED PAPERS. ZERO-DIMENSIONAL PROPERTIES ARE SCALARS

Dimensions	Property	[12]	[6]	[1]	[13]	[11]	[20]	This paper
2	Spreading (or scattering) function			x				x
	Time-varying impulse response				x			x
1	Power delay profile		x				x	x
	Doppler power spectrum							x
	Correlation function			x				
	Level crossing rate				x	x	x	
	Average fade duration					x		
0	Delay spread							x
	Doppler spread		x					x
	Rice number		x					
	BER	x		x		x		x
	PER							x
	Output SINR			x				x

C. Handling of Doppler Shifts and Noise

The estimated mean Doppler shift is removed from the TVIR estimate before application of the channel simulator, and reinserted at the simulator output. This is done by applying resampling as required to rescale the time axis. Apparent Doppler shifts may occur even in the case of stationary transmitters and receivers. In that case, the shift is due to deviations of instrument clock frequencies from their nominal values. The effect of a clock-frequency mismatch is an apparent time dilation/compression and corresponding frequency shift, the same effect as that of a genuine Doppler shift. As an example, for the data used in Section V, which were obtained with stationary transmitters and receivers, an apparent Doppler shift corresponding to -0.142 m/s is removed and reinserted.

The correlative sounder used to estimate the TVIR of an *in situ* measurement has a processing gain and reduces the effect of noise. Ideally, the channel replay only reproduces the TVIR and not noise. Noise should, therefore, be added to the simulator output. In validation study II, noise is added at the same signal-to-noise ratio (SNR) as observed in the ocean data. The noise is produced by the noise model of [18], which generates non-Gaussian wind noise with an empirical power spectral density from [19] using the method of [20]. Further details on the noise model are not provided, since the validations in Sections IV and V use high-SNR scenarios where communication performance is limited by channel dynamics rather than noise. In other words, the noise characteristics are not very important.

III. CHANNEL SIMULATOR VALIDATION

A. Output Properties for Validation

A prerequisite for operational validation is to have experimental data available. The experimental data are collected using

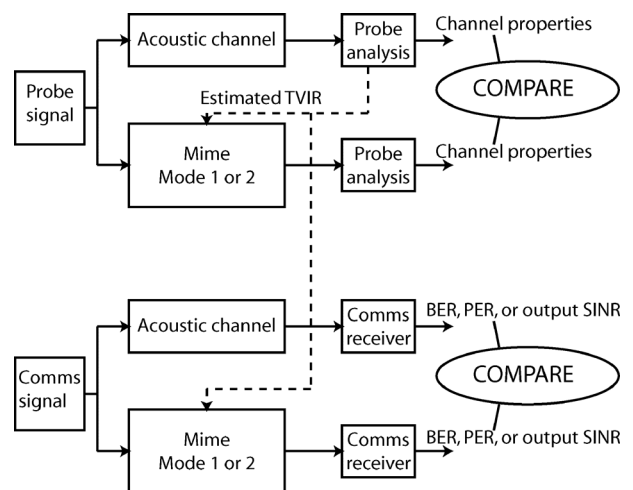

Fig. 1. Validation method.

a transmitter and a receiver in the sea, and the transmitted signals should include channel probe signals tailored to estimate channel conditions, and also communication signals to evaluate communication performance.

Various analyses can be applied to the experimental data, which result in measured quantities or “output properties.” The same properties are subsequently estimated from the simulator output, and a qualitative or quantitative comparison is made. Properties to be compared can be variables of 0, 1, or 2 (or even higher) dimensions. By 0-dimensional variables we mean scalars, which are the easiest to compare and are suitable for validations using large data sets. One- or two-dimensional variables contain more details and are suitable for detailed study of a few transmissions.

Table I lists various output properties that may be used for validation, and gives an overview of which properties have been presented in a validation context in selected papers on underwater acoustic communication channel simulators [1],

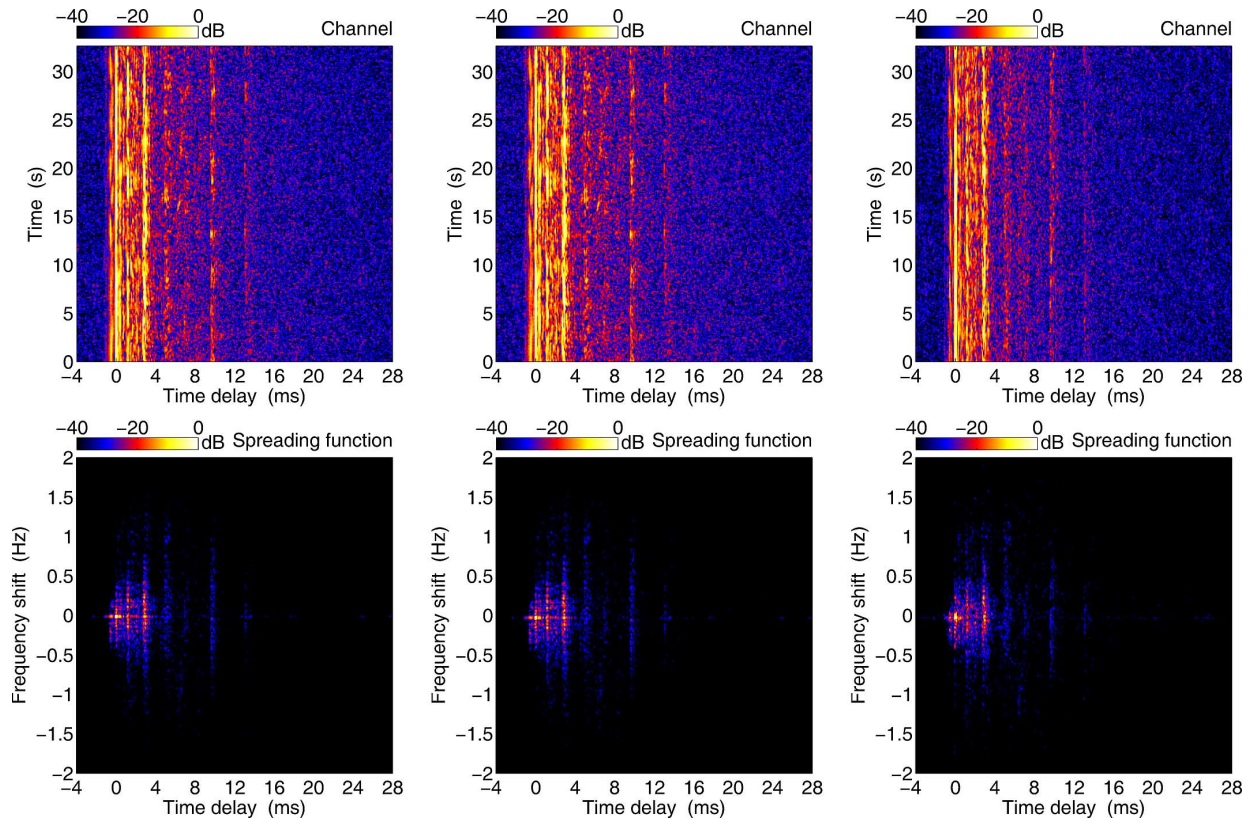

Fig. 2. Example of a qualitative validation using 2-D quantities. Top row: TVIR. Bottom row: Spreading function. Left column: *In situ* measurement. Center column: Direct replay. Right column: Stochastic replay.

[6], [12]–[14], [21].¹ The right-hand column shows which properties are discussed in this paper.

The bit error rate (BER), the packet error rate (PER), and the output signal-to-interference-plus-noise ratio (SINR) are the most common metrics used in evaluation of point-to-point communication schemes. These are computed using communication signals, while the remaining properties in the table are normally obtained from channel probe signals. In all cases, the properties must be clearly defined. For example, the root mean square (RMS) or the 90% energy criterion can be used for delay spread and Doppler spread [16].

To validate a channel simulator, supporting data are required. Replay simulators require channel estimates obtained from *in situ* transmissions of channel probe signals. Using the same probe signal transmission for configuration and validation will demonstrate the simulator’s ability to mimic the channel properties, while the use of different probe signal transmissions (close in time) will demonstrate its ability to generalize results from a single transmission in cases where channel conditions are stationary. Validation of model-based simulators requires a comprehensive set of environmental data (sound-speed profiles, wave spectra, bathymetry, etc.) in addition to *in situ* recordings of channel probe and communication signals.

¹Van Walree and Otnes [21] simultaneously validate wideband properties, which are not considered in this paper. In wideband propagation channels, the properties listed in Table I may depend on the frequency. In that case, an extra dimension has to be added to account for variation with frequency.

B. Validation Method for Direct and Stochastic Replay Channel Simulators

The proposed validation method requires a software tool which can estimate and display the time-varying impulse response and related variables, based on received channel probe signals. We refer to this as “probe analysis.” The validation method, depicted in Fig. 1, is as follows:

- analyze a probe signal received in a real acoustic channel to obtain an estimate of the channel conditions, for instance, the TVIR;
- configure the channel simulator to replay the channel conditions in mode 1 (direct replay), or generate channel conditions with the same statistical properties in mode 2 (stochastic replay);
- run the probe signal of the first step through the channel simulator and probe analysis, and compare the output properties with those of the probe signal received at sea;
- run communication signals through the channel simulator, and compare communications performance with the performance of at-sea transmissions of the same communication signals.

The transmissions of communication signals should be reasonably close in time to the transmission of the configuration probe signal, to reduce the possible effect of channel nonstationarity. The risk of nonstationary channels can be mitigated by transmitting the probe and communication waveforms many

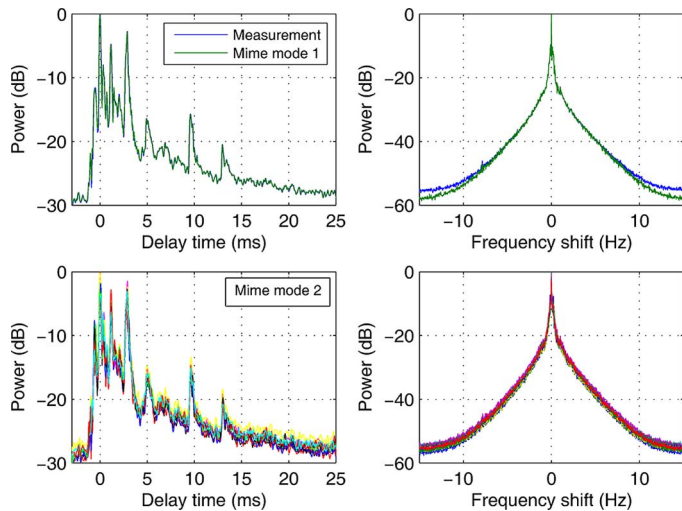

Fig. 3. Example of using 1-D properties for validation. The bottom plots show ten realizations in mode 2 (stochastic replay).

times in a cyclic fashion, and examine long-term error statistics such as the PER rather than the BER of a single transmission.

IV. VALIDATION STUDY I: AUTUMN, 10–18 KHz

The first validation study also serves to illustrate the validation method by examples. The acoustic data were collected in a Norwegian fjord environment in October, with the source and the receiver mounted on stationary bottom frames. The water depth varied between 9 and 17 m over the 1.2-km track, with propagation influenced by an upward refracting sound-speed profile. A pseudonoise probe signal is considered with repetition period 32 ms, and is analyzed as described in [16]. The median SNR of the recorded data is 29 dB.

A. Reproduction of Channel Properties

Fig. 2 shows an example of measured and simulated TVIRs and delay-Doppler spread functions. This example corresponds to “channel H” in [16], but uses a different probe signal. The figure shows that the channel simulator replays the time-varying impulse response very well in direct replay. In stochastic replay, it reproduces the spreading function, but provides a different TVIR. This is correct behavior, since the motivation for this simulation mode is to provide different channel realizations with the same statistical properties.

The use of 2-D properties for validation is suitable for detailed study of selected channels, but mainly facilitates qualitative/subjective judgments as above. It would also be impractical and cumbersome to use 2-D validations for a large number of measured channels.

Fig. 3 shows 1-D output properties for the same example channel, in this case the power delay and Doppler profiles. These are more suitable for quantitative assessment. For example, it is observed that direct replay reproduces the Doppler spectrum exactly down to about -50 dB, and one gets to see how much stochastic variation there is between different realizations of the stochastic replay. Still, it is impractical to use 1-D properties for a large number of measured channels.

Fig. 4 gives an example of a channel where the stochastic replay operates outside its domain of applicability. This channel (“channel F” in [16]) has a cyclostationary component in the form of a path with a time-varying delay due to interaction with surface gravity waves. It is similar to channels that have recently been analyzed in [22]. Since the statistical model used to configure the stochastic replay assumes channel stationarity, this mode fails to reproduce the cyclostationary feature. By contrast, direct replay (not shown) delivers a true-to-life reproduction of the measured channel.

A lot of information is lost when a TVIR is reduced to a few scalars, but an advantage is that a large data set becomes amenable to batch processing, visualization in a single figure, and a quantitative analysis. An example is shown in the top panels of Fig. 5, which plot the delay spread and Doppler spread computed from probes from 100 consecutive transmit cycles with 6-min time spacing. The channel in Figs. 2 and 3 corresponds to the first of these 100 cycles.

The root mean squared deviation (relative to measurement) in delay and Doppler spread is 0.084 ms and 0.053 Hz for direct replay, and 1.107 ms and 0.246 Hz for stochastic replay (averaged over ten realizations for each transmission cycle). Outliers in such a scalar (0-D) validation may become candidates for a detailed 1-D or 2-D inspection.

B. Prediction of Communications Performance

It is important to the end user that a channel simulator can be used for realistic performance prediction of communication systems. Therefore, it is recommended to include communication signals in the validation. Here, we use an early version of the JANUS signal [23] with v0.3 receiver code, and a direct-sequence spread spectrum (DSSS) signal with the same bandwidth and the same net data rate of 80 b/s. JANUS is an incoherent scheme that uses frequency-shift keying, whereas DSSS is a coherent scheme with a much more computationally expensive receiver. More details on the two schemes and a comparison of their performances can be found in [24].

The bottom panels of Fig. 5 give the measured and simulated communications performance for the same transmit cycles considered in the top panels. The JANUS panel shows the BER before decoding of the error-correcting code. Across this data set, the mean (median) BER is 0.073 (0.082) for the *in situ* transmissions, 0.095 (0.084) for simulation mode 1, and 0.079 (0.083) for simulation mode 2. The median value is more robust to outliers than the mean value in such comparisons.

The BER is the ultimate performance measure for a communications receiver, but in some cases, it makes more sense to use the receiver output SINR for validation, if available, since the BER can be a strongly nonlinear function of output SINR. For DSSS, there were very few bit errors even before the decoder, and it was decided to use the output SINR for this scheme. Across this data set, the mean SINR is 20.9 dB for the *in situ* data, 22.3 dB for direct replay, and 22.1 dB for stochastic replay. The similarity between the two simulation modes shows that stochastic replay reproduces the measured channel conditions

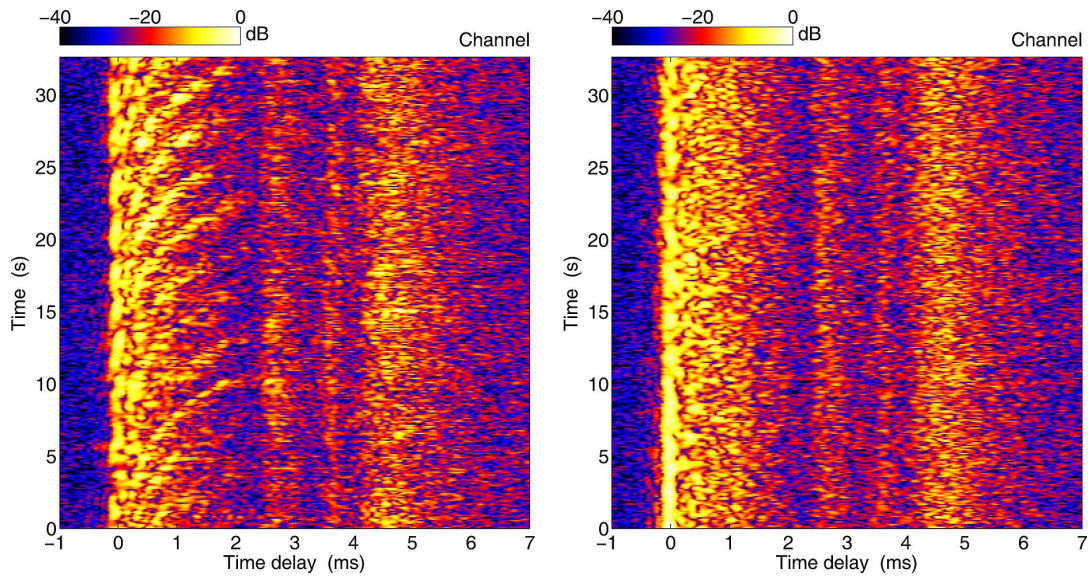

Fig. 4. Example of a validation to identify cases where the channel simulator is outside its domain of applicability. (a) Measurement. (b) Stochastic replay.

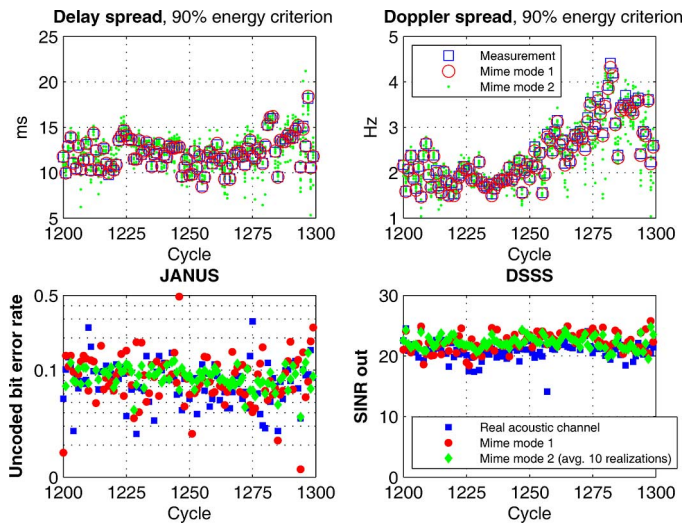

Fig. 5. Example of using scalar properties for validation across many transmit cycles. Top: The channel properties delay spread and Doppler spread. Bottom: The communication properties BER and output SINR, for two different communication schemes.

well, at least as far as the DSSS scheme is sensitive to these conditions, while the small discrepancy between the real acoustic channel and direct replay tells that the channel dynamics are not completely captured by the channel sounding used to configure the simulator. One cause of mismatch is aliasing in delay [25], which arises because the true channel has an extended but weak reverberation tail, whereas the length of the measured channel is limited to the 32-ms sounding period of the probe signal. Furthermore, additive noise is not considered in this simulation study. The acoustic data have an SNR of about 30 dB, whereas the simulator output has infinite SNR.

V. VALIDATION STUDY II: SPRING, 4–8 KHZ

This study validates the channel simulator for an acoustic data set collected in the Oslofjord, Norway, in May 2012, in the 4–8-kHz frequency range.

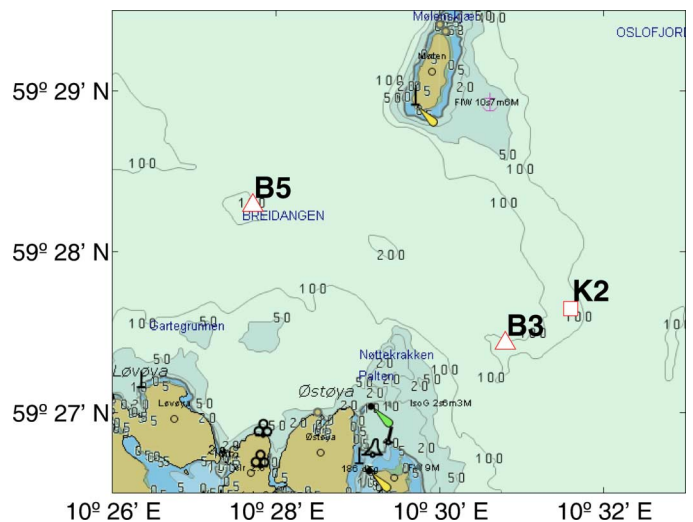

Fig. 6. Position of transmitter K2 and receivers B3 and B5, in the Oslofjord outside Horten, Norway.

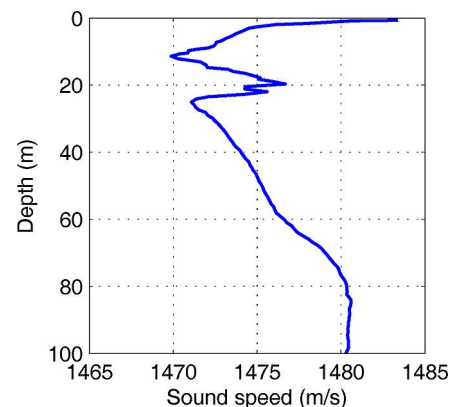

Fig. 7. Typical sound-speed profile for the data set of validation study II.

A. Data Set Used for Validation

Two signaling tracks are considered, using the transmitter position K2 and receiver positions B3 and B5 as marked on the map in Fig. 6. The distance K2B3 measures 0.85 km, and the distance K2B5 is 3.86 km. The transmitters and receivers were

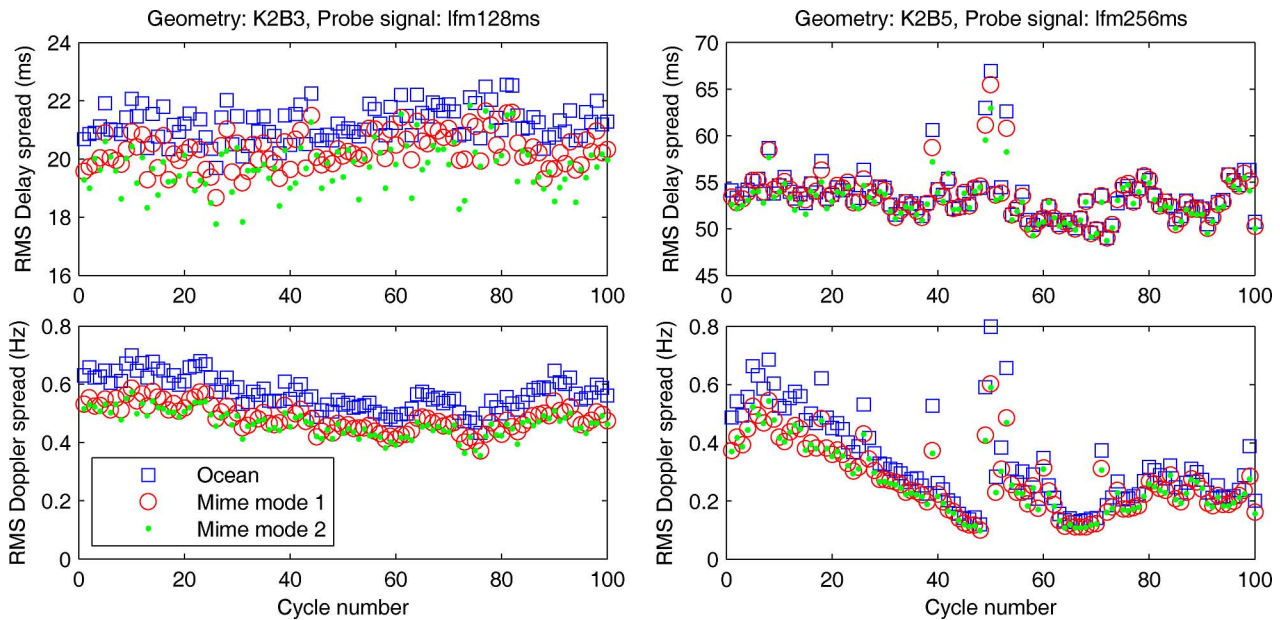

Fig. 8. RMS delay and Doppler spreads measured in the ocean and in the channel simulator output. Note that the delay spread axis is different for the two geometries.

mounted in stationary frames placed on sea mounts and ridges, at water depths between 70 and 80 m. The transmitter source level was about 177 dB re $1 \mu\text{Pa}^2 \cdot \text{m}^2$, and single-hydrophone receivers were used. The median SNR in the recorded data is 34 dB for the K2B3 geometry, and 21 dB for the K2B5 geometry. Sound-speed profiles were measured during the tests. A typical example is shown in Fig. 7.

The transmit cycle, which was repeated every 10 min, consisted of four channel probe signals and a variety of communication signals. The probe signals had different tracking periods T , which allows choosing a probe with a suitable tradeoff between delay and Doppler coverage in the simulations. The communication schemes investigated in this validation study are summarized in Section V-C1. One hundred consecutive transmit cycles are examined, collected over the 1000-min time span May 21 at 16:10:00Z to May 22 at 08:50:00Z. According to AIS data, only six ships passed close to the measurement site in this time span. The sea state was low and there was no precipitation.

B. Reproduction of Channel Properties

Out of the four transmitted probe signals, the most suitable to match the power delay profile of the channel is an LFM chirp train with period $T = 128$ ms for the K2B3 track, and an LFM chirp train with period $T = 256$ ms for the K2B5 track. For each of the 100 cycles, the simulator is configured to reproduce the channel estimated from the probe signal of the chosen type, received in that cycle. The input signals passed through the channel simulator are 1) the same probe signal that was used to configure it, and 2) the communication waveforms. The procedure is sketched in Fig. 1.

Delay and Doppler spread are compared between the *in situ* (ocean) and simulated channels, by analyzing the received probe signals. The results are shown in Fig. 8, which uses the RMS definition of delay and Doppler spread [16]. The spread values in the simulated channels are close to, but slightly smaller than,

the ocean values. Further, the delay spread in stochastic replay is sometimes slightly smaller than in direct replay. The disturbances around cycle 50 in the K2B5 graphs are not channel fluctuations, but measurement errors due to the noise of ships passing close to the receiver.

Fig. 8 suggests that the channel conditions do not vary much throughout the 17 h covered by the 100 measurement cycles. For a more detailed study, we now select one cycle from each track, with RMS delay and Doppler spreads close to the median value for that track. The delay-Doppler spread functions measured in these cycles are shown in Fig. 9.

Fig. 10 compares 1-D ocean data to the corresponding channel simulator output for the selected cycles. The delay profiles are well reproduced by the channel simulator, although inclusion of the 256-ms ocean profile in the K2B3 panel reveals that the 128-ms observation window is too short to capture all delayed arrivals. The arrival cluster at -25 dB relative to the maximum (at 120 ms in the graph) has been aliased in the 128-m sounding. There it appears at a false delay, and is not visible owing to other paths at the same apparent delay. Since the channel simulator faithfully reproduces the 128-ms measurement, the replayed channel has a smaller delay spread than the physical channel. Note, however, that the delay spread of about 21 ms for “Ocean” shown in Fig. 8 is measured using the 128-ms probe and, hence, also lacks this propagation path. If the 256-ms probe is used, the RMS delay spread measured for K2B3 increases to about 34 ms.

Fig. 10 also shows that the main features of the measured Doppler spectrum are well reproduced. The main reason for the simulated Doppler spectrum to fall off faster than the ocean Doppler spectrum toward the Nyquist frequency of the sounder is the nonflat frequency response of the linear interpolation. This results in a channel with a slightly reduced fluctuation rate, and an RMS Doppler spread which is slightly too small, as seen in Fig. 8. The deviation becomes larger for channels whose

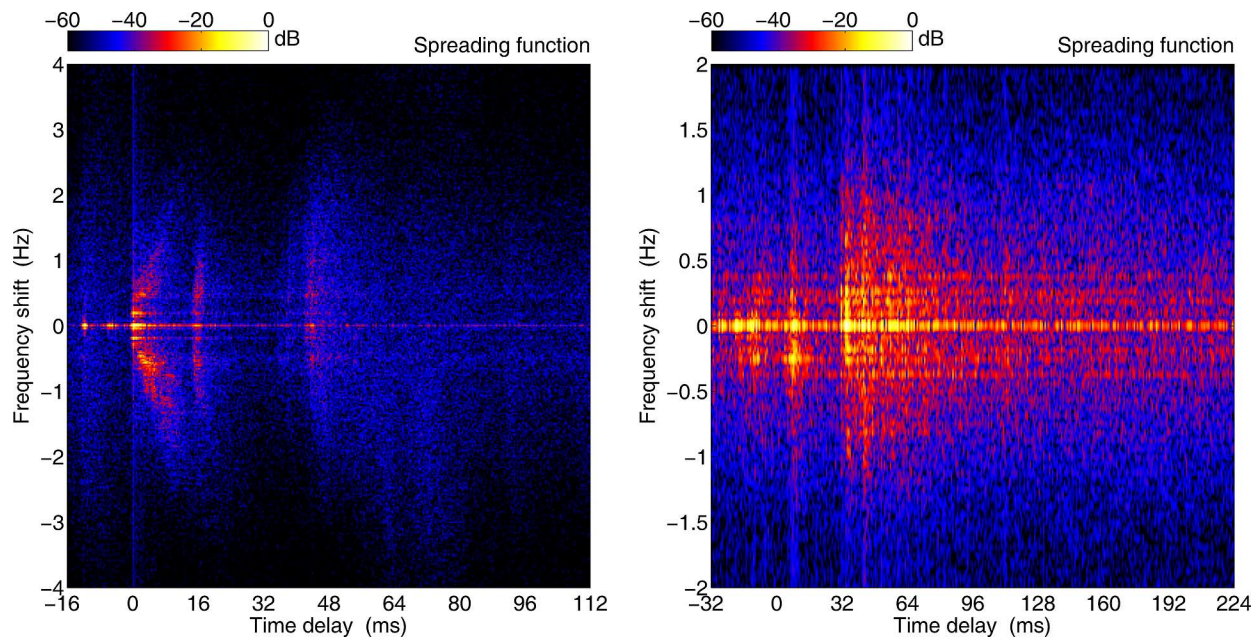

Fig. 9. Measured delay-Doppler spread functions for selected cycles. (a) K2B3 geometry, cycle 66. (b) K2B5 geometry, cycle 87. The delay axis has an arbitrary offset.

Doppler spectra have significant energy close to the Nyquist frequency.

C. Prediction of Communication Performance

This section investigates the simulator's ability to predict communications performance. This is achieved by comparing the actual and simulated performance of communication schemes whose waveforms were transmitted alongside the probe signals during the sea experiment. Successful validation in this respect allows simulation to be used retrospectively to predict how communication signals would perform, if they had been transmitted through the measured channels.

1) *Communication Schemes*: Table II lists ten communication signals. The message size and data rate in the table are referred to information bits, while the duration incorporates all physical layer overhead including synchronization preambles. The acronyms used for the signals are just designations and not very informative about the underlying algorithms. A brief description of the schemes is provided below. A detailed description is beyond the scope of this paper, as the objective is not to evaluate communication performance, but to evaluate simulation performance.

The signals denoted DSSS, frequency-repetition spread spectrum (FRSS), and time-repetition spread spectrum (TRSS) are variations on the spread spectrum theme. These three schemes use a common receiver architecture based on an adaptive decision-feedback equalizer. DSSS is implemented with hypothesis-feedback equalization [26]. FRSS is a simplified version of the multicarrier scheme described in [27]. TRSS is a new variation which is potentially more robust to collisions in network applications. Both FRSS and TRSS employ joint equalization and despreading.

The signal named UOFDM is a multiband implementation of orthogonal frequency-division multiplexing (OFDM). It is im-

plemented as the R2 signal described in [28], with only two differences: a single turbo code block is used and the center frequency is shifted to 6 kHz. The signal named OFDM is a modified version of UOFDM, with changes applied to carry smaller messages at a higher data rate.

The multiscale-multilag (MSML) channel model is at the basis of the MSML signals. This channel model explicitly considers paths with different travel times (lags) and different Doppler scales. Transmitter and receiver architectures are described in [29].

The schemes named 4PSK and 8PSK (phase-shift keying) are the single-carrier turbo equalization schemes used in [30], but shifted to the 4–8-kHz frequency band for the present study. The demodulation of these 4PSK and 8PSK schemes on a fast computer is significantly slower than real time. MSML is also slow, whereas demodulation of the six other signals is significantly faster than real time. All schemes are operated with fixed parameters and are not optimized for any particular channel.

2) *Validation Using Numerous TVIR Measurements*: In this section, the communication signals are passed through 100 different channels, corresponding to the TVIR measurements of the 100 transmit cycles. Noise is added to the filtered signals, as described in Section II-C. The PER and the BER of the simulator output are compared to the actual PER and BER of the ocean recordings, of the same communication signals in the same 100 transmit cycles. The resulting performance is shown in Fig. 11. This graphical representation has a high information density, and should be read as follows: The horizontal bar represents the PER, where a packet is defined as one transmission of the signal. The amount of green represents the fraction of packets received without errors, and the amount of red represents the fraction of packets with one or more bit errors. Green is good; red is bad. The black triangle represents the BER, averaged over the 100 packets. A triangle at the far left of the bar corresponds to a

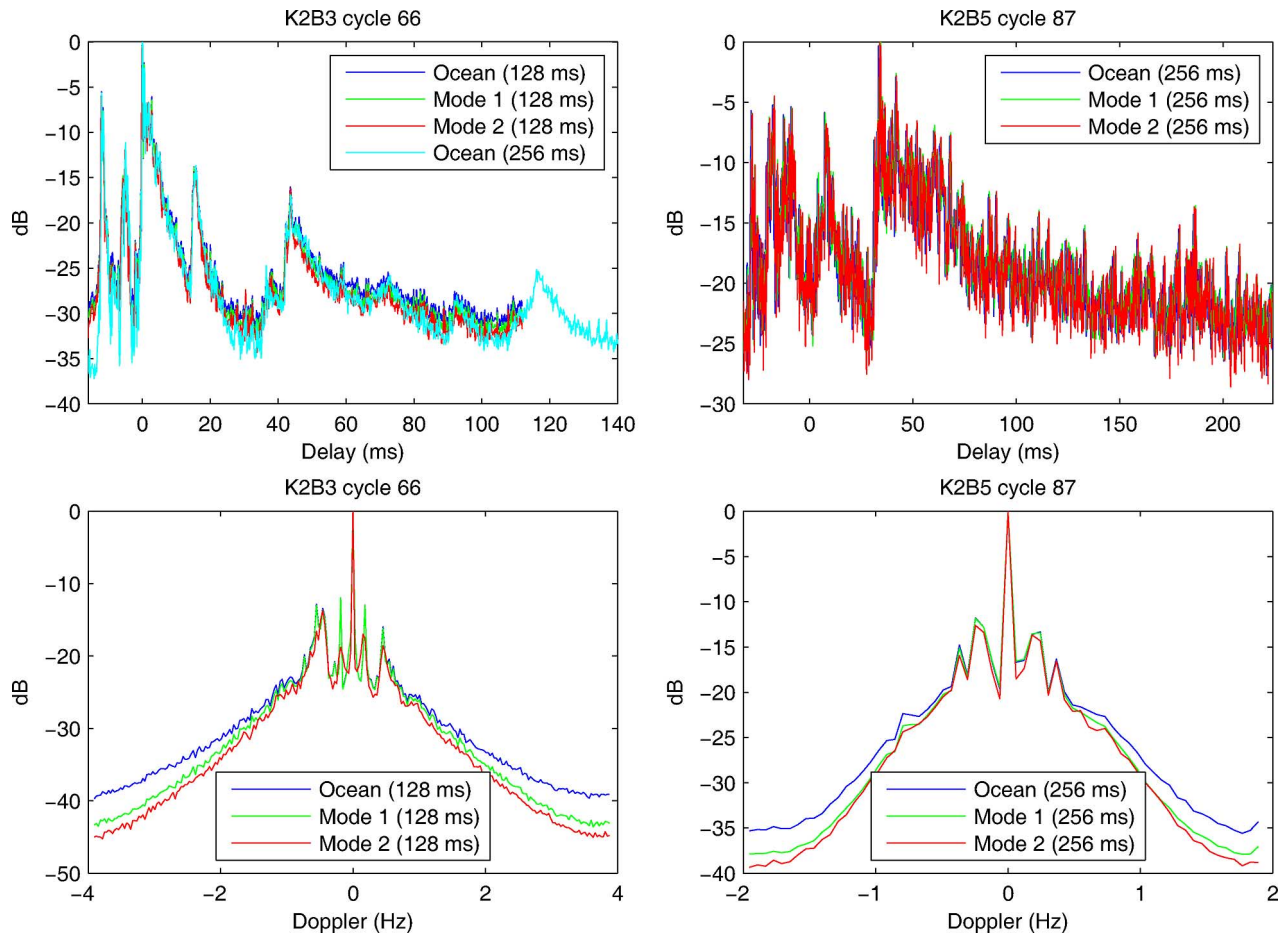

Fig. 10. Delay and Doppler profile measured in the ocean and in the channel simulator output, for selected cycles. “Ocean” is the real-world (*in situ*) measurement, “Mode 1” is direct replay, and “Mode 2” is stochastic replay. All curves are normalized to yield a peak value of 0 dB, and the delay axis has an arbitrary offset.

TABLE II
SUMMARY OF COMMUNICATION SIGNALS USED IN VALIDATION STUDY II

Name	Size (bits)	Duration (s)	Rate (bits/s)
OFDM2	128	0.75	172
MSML1	256	3.31	77
MSML3	512	2.49	206
DSSS1	256	4.62	55
DSSS3	512	2.29	223
FRSS3	512	2.70	190
TRSS3	512	2.79	183
UOFDM	637	8.18	78
4PSK	2045	0.88	2323
8PSK	3069	0.88	3486

mean BER of 50%, and a triangle at the far right corresponds to a mean BER of 0. Right is good; left is bad.

Fig. 11 shows that the channel simulator predicts the actual values of PER and BER more than well enough to see which schemes perform well or badly in the given environment. Overall, the predicted communication performance seems slightly too optimistic. In all likelihood, this is due to aliasing in the channel sounding [25]. The acoustic channels have a

reverberation tail that is weak but long, containing energy beyond the windows of 128 and 256 ms covered by the LFM probe signals. This energy is aliased in delay so that the delay spread of the simulated channels is somewhat shorter than that of the true ocean channels. A similar argument applies to the Doppler spectrum, where frequency aliasing may occur. Furthermore, it was shown in Fig. 10 that the simulated channels have a reduced power spectral density toward the boundaries of the spectrum. Both the delay spread and the Doppler spread are thus a bit lower in simulation than in the ocean. As a result, the predicted performance is slightly too optimistic. This cannot be concluded from a single demodulation, but requires long-term statistics such as the PER. Also note that, with a few minor exceptions, the channel simulator correctly predicts the relative performance of the communication schemes, *i.e.*, which schemes perform better than other ones.

3) *Validation Using One TVIR Measurement*: One may not often have the luxury of numerous channel soundings, as in Section V-C2. To investigate to what extent a single sounding enables prediction of long-term error statistics, the communication signals are now passed through 100 different realizations of a single TVIR. Stochastic replay simply achieves this by generating 100 independent realizations compliant with the scattering function of the selected TVIR. This is not possible with direct replay, but here one can take advantage of the fact that the probes have a longer duration than the communication signals.

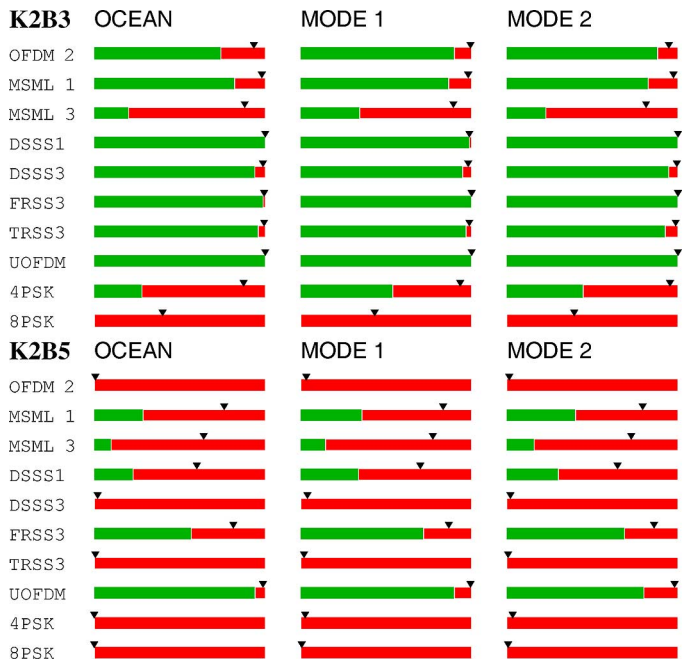

Fig. 11. Comparison of PER and BER between *in situ* signaling and simulations, for the case where the channel simulator is configured using different TVIR measurements for each transmission. K2B3 and K2B5 are two different measurement geometries. “Ocean” is the real-world communication performance, “Mode 1” is direct replay, and “Mode 2” is stochastic replay. {OFDM2, . . . , 8PSK} are different communication schemes. The green/red bars show the packet error rate (all-green for PER = 0, all-red for PER = 1). The triangles show the BER on a linear scale from 0.5 on the left to 0 on the right. See Section V-C2 for further details. (In printed black and white version, grey represents green and black represents red.)

The sounding duration is 32 s for the K2B3 probe and 16 s for the K2B5 probe; the duration of the communication signals is listed in Table II. The input signals can then be passed through the channel simulator using different sections of the measured TVIR. Since the ratio between probe signal duration and communication signal duration is smaller than 100, there will be overlap between the TVIR sections. The 100 realizations in direct replay are thus not statistically independent.

The simulator is configured using cycle 66 for track K2B3 and cycle 87 for track K2B5. See Figs. 9 and 10 for the spreading function, delay profile, and Doppler spectrum. These are representative cycles for each geometry, in the sense that the RMS delay and Doppler spreads are close to the median of the data set.

The resulting simulated communication performance is compared with the at-sea performance, which still represents a 1000-min time span, in Fig. 12. The difference between predicted and actual performance is not larger than in Fig. 11, which is quantitatively confirmed by Tables III and IV. This is remarkable, considering that the number of soundings used to configure the channel simulator has been reduced from 100 to 1.

It is the relatively stationary nature of the channel over the 1000 min, as judged from Fig. 8, which makes it possible to predict the performance so well from a single measurement. These results justify the use of a stochastic replay channel simulator

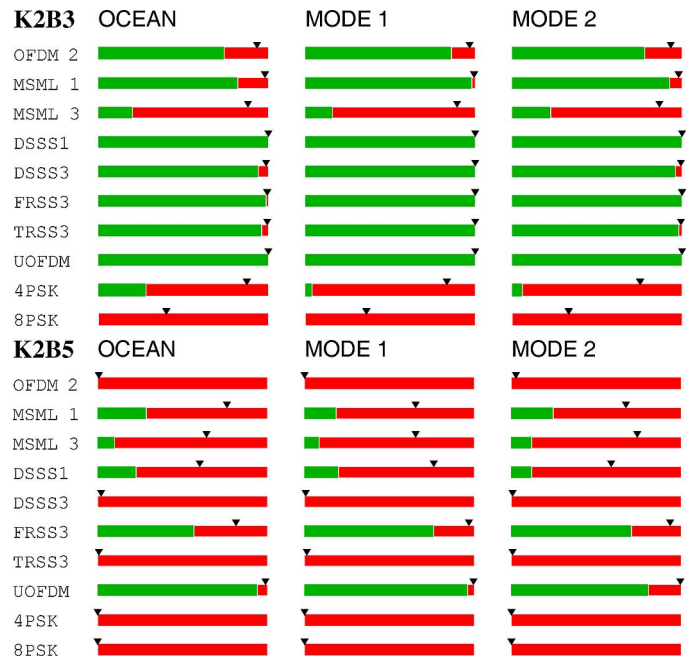

Fig. 12. Comparison of PER and BER between *in situ* signaling and simulations, for the case where the channel simulator generates 100 realizations from a single TVIR measurement. K2B3 and K2B5 are two different measurement geometries. “Ocean” is the real-world communication performance, “Mode 1” is direct replay, and “Mode 2” is stochastic replay. {OFDM2, . . . , 8PSK} are different communication schemes. The green/red bars show the packet error rate (all-green for PER = 0, all-red for PER = 1). The triangles show the BER on a linear scale from 0.5 on the left to 0 on the right. See Section V-C2 for further details. (In printed black and white version, grey represents green and black represents red.)

to generate multiple realizations of a previously measured channel to accurately predict PER and BER, for example, to compare candidate communication schemes. Note that the condition of channel stationarity, which plays an important role in this comparison, may not be met in other settings. However, that is an issue for validation of channel simulators, not application: It is always possible to take a single channel sounding and use it for extended stochastic simulations to find communication performance under stationary conditions, even if the stationarity of the *in situ* channel does not persist beyond the time span of the sounding. However, a meaningful validation of the stochastic replay with long-term results from the real world becomes impossible, because of the mismatch in channel conditions.

So far, the discussion on simulation performance has mostly been of a qualitative nature. Tables III and IV present a quantitative comparison. Δ PER is the difference between predicted and real-world PER, and Tables III and IV give the number of signal types for which this difference is below different thresholds. The difference is below 0.20 in all cases, except for one scheme (4PSK) in the K2B3 geometry. Note that a perfect match at small Δ PER would not occur even with a perfect channel simulator, since the probe and communication signals were transmitted at different instants during the sea experiment. The number of 100 cycles is large enough for an overall picture of simulation fidelity, but too small to make PER deviations of a few percent significant.

TABLE III
COMPARISON OF SIMULATION MODES FOR THE K2B3 GEOMETRY

Replay mode	Configuration	$ \Delta\text{PER} \leq 0.02$	$ \Delta\text{PER} \leq 0.05$	$ \Delta\text{PER} \leq 0.10$	$ \Delta\text{PER} \leq 0.20$
Direct	100 TVIRs	4/10	6/10	7/10	9/10
Stochastic	100 TVIRs	4/10	8/10	8/10	9/10
Direct	1 TVIR	6/10	6/10	7/10	9/10
Stochastic	1 TVIR	6/10	8/10	8/10	10/10

TABLE IV
COMPARISON OF SIMULATION MODES FOR THE K2B5 GEOMETRY

Replay mode	Configuration	$ \Delta\text{PER} \leq 0.02$	$ \Delta\text{PER} \leq 0.05$	$ \Delta\text{PER} \leq 0.10$	$ \Delta\text{PER} \leq 0.20$
Direct	100 TVIRs	5/10	6/10	8/10	10/10
Stochastic	100 TVIRs	5/10	5/10	7/10	10/10
Direct	1 TVIR	6/10	8/10	8/10	10/10
Stochastic	1 TVIR	5/10	7/10	7/10	10/10

VI. CONCLUSION

An overview has been presented of quantities that may be used for validation of underwater acoustic communication channel simulators. Scalar (0-D) communication and channel parameters are most suitable for validation based on large data sets, while 1-D and 2-D channel functions are suited for detailed investigation of selected transmissions.

Validation methods are proposed for channel simulators based on direct and stochastic replay of measured TVIRs, and the results of two validation studies are presented for such a simulator. The channel simulator predicts the PER and BER performance of each tested communication scheme well from a qualitative perspective, and reproduces the relative performance differences between schemes. This is also true when 100 channel realizations generated from a single channel sounding are compared to 100 real-world transmissions over a 1000-min time span. Quantitatively, the difference between the predicted and real-world PER is smaller than 0.20 in all studied cases, except for one communication scheme in the K2B3 geometry.

The observed PER deviations have three causes. First, there are measurement errors in the TVIR used to configure the simulator. These are known as channel estimation errors, and occur with any estimation method. In the case of a correlative sounder, for instance, aliasing may occur in delay and/or in frequency. Second, there are simulation errors. The channel simulator may fail to reproduce certain characteristics of the TVIR. An example is the reduced power spectral density toward the Nyquist frequency of the sounder, as illustrated in Fig. 10. Third, there are statistical fluctuations. The use of “only” 100 transmissions can yield PER deviations of a few percent even in the absence of measurement and simulation errors.

The fact that the deviations are smaller than 0.20 implies that, after initial data collection at sea, stochastic replay can be used to assess the performance of communication schemes not existing at the time of initial data collection. Figs. 11 and 12 indicate that the accuracy of the performance prediction is more than sufficient to tell whether a communication scheme is robust, i.e., whether the PER is close to 0 or close to 1. Relative

performance differences between schemes are also reproduced, so replay simulation can be used to tell which of two (or more) schemes performs best in a given environment, except when the difference is marginal. Direct replay can also be used to compare schemes, but it is not suited to produce a large number of independent realizations from a single TVIR measurement.

On the other hand, direct replay can handle more types of channels than stochastic replay. The data considered in this paper mainly concern stationary channels within the domain of applicability of stochastic replay, except for the cyclostationary channel in Fig. 4. A general limitation of the stochastic replay, as currently implemented, is that it cannot reproduce the frequency-dependent fading statistics that characterize wideband propagation channels. This would require, for instance, correlated taps to accommodate frequency-dependent attenuation, or time-varying time delays in MSML channels. It is shown in [21] that direct replay has this ability.

ACKNOWLEDGMENT

Mime was developed as part of the Norwegian Defence Research Establishment (FFI) Simulation and Modeling of the Acoustic Time-Varying Underwater Channel (SMATUC) and European UUV Covert Acoustic Communications (UCAC) projects, and is also used in the European Defence Agency (EDA) project Robust Acoustic Communications in Underwater Networks (RACUN), where it has been improved further. The acoustic data set used for validation study II was collected by FFI and Kongsberg Maritime (KM), as part of the EDA project RACUN. The RACUN project is part of the European Unmanned Maritime Systems for MCM and Other Naval Applications (EDA-UMS) program, and is funded by the Ministries of Defence of the five participating nations: Germany, Italy, The Netherlands, Norway, and Sweden. The authors would like to thank V. Forsmo and H. Buen from FFI, F. T. Knudsen and T. Husøy from KM, and the crew of *M/S Simrad Echo*, for their efforts in the sea trials and the collection of data. They would also like to thank The Netherlands Organisation for Applied Scientific Research (TNO) and Delft University

of Technology for permitting the use of OFDM and MSML in validation study II.

REFERENCES

- [1] P. A. van Walree, T. Jenserud, and M. Smedsrud, "A discrete-time channel simulator driven by measured scattering functions," *IEEE J. Sel. Areas Commun.*, vol. 26, no. 9, pp. 1628–1637, Dec. 2008.
- [2] A. Zielinski, Y. Yoon, and L. Wu, "Performance analysis of digital acoustic communication in a shallow water channel," *IEEE J. Ocean. Eng.*, vol. 20, no. 4, pp. 293–299, Oct. 1995.
- [3] I. Karasalo, T. Öberg, B. Nilsson, and S. Ivanson, "A single carrier turbo coded system for underwater communication," in *Proc. Underwater Commun., Channel Model. Validation*, Sestri Levante, Italy, Sep. 2012.
- [4] X. Geng and A. Zielinski, "An eigenpath underwater acoustic communication channel model," in *Proc. MTS/IEEE OCEANS Conf.*, Seattle, WA, USA, Oct. 1995, vol. 2, pp. 1189–1196.
- [5] M. Chitre, "A high-frequency warm shallow water acoustic communications channel model and measurements," *J. Acoust. Soc. Amer.*, vol. 122, no. 5, pp. 2580–2586, Nov. 2007.
- [6] X. Cristol, "NARCISSUS-2005: A global model of fading channel for application to acoustic communication in marine environment," in *Proc. OCEANS Eur. Conf.*, Brest, France, Jun. 2005, pp. 655–662.
- [7] M. Siderius and M. B. Porter, "Modeling broadband ocean acoustic transmissions with time-varying sea surfaces," *J. Acoust. Soc. Amer.*, vol. 124, no. 1, pp. 137–150, Jul. 2008.
- [8] E. A. Karjadi, M. Badiey, J. T. Kirby, and C. Bayindir, "The effects of surface gravity waves on high-frequency acoustic propagation in shallow water," *IEEE J. Ocean. Eng.*, vol. 37, no. 1, pp. 112–121, Jan. 2012.
- [9] H. S. Dol, M. E. G. D. Colin, M. A. Ainslie, P. van Walree, and J. Janmaat, "Simulation of an underwater acoustic communication channel characterized by wind-generated surface waves and bubbles," in *Proc. Underwater Commun., Channel Model. Validation*, Sestri Levante, Italy, Sep. 2012.
- [10] S. Schlesinger, R. E. Crosbie, R. E. Gagne, G. S. Innis, C. S. Lalwani, J. Loch, R. J. Sylvester, R. D. Wright, N. Kheir, and D. Bartos, "Terminology for model credibility," *Simulation*, vol. 32, no. 3, pp. 103–104, 1980.
- [11] R. G. Sargent, "Verification and validation of simulation models," in *Proc. Winter Simul. Conf.*, Orlando, FL, USA, Dec. 2005, pp. 130–143.
- [12] F.-X. Socheleau, C. Laot, and J.-M. Passerieux, "Stochastic replay of non-WSSUS underwater acoustic communication channels recorded at sea," *IEEE Trans. Signal Process.*, vol. 59, no. 10, pp. 4838–4849, Oct. 2011.
- [13] R. Galvin, R. F. W. Coates, L. S. Wang, and R. Stoner, "Measured channel sounding characteristics and their relationship with the performance of a parametric communication system," in *Proc. MTS/IEEE OCEANS Conf.*, Fort Lauderdale, FL, USA, Sep. 1996, vol. 2, pp. 826–831.
- [14] F.-X. Socheleau, C. Laot, and J.-M. Passerieux, "Concise derivation of scattering function from channel entropy maximization," *IEEE Trans. Commun.*, vol. 58, no. 11, pp. 3098–3103, Nov. 2010.
- [15] T. Jenserud, P. van Walree, and R. Otnes, "An underwater acoustic channel simulator," in *Proc. 35th Scandinavian Symp. Underwater Acoust.*, Geilo, Norway, Jan. 2012.
- [16] P. van Walree, "Channel sounding for acoustic communications: Techniques and shallow-water examples," Norwegian Defence Res. Establishment (FFI), Kjeller, Norway, FFI-rapport 2011/00007, 2011.
- [17] A. F. Molisch, "Ultrawideband propagation channels—Theory, measurement, and modelling," *IEEE Trans. Veh. Technol.*, vol. 54, no. 5, pp. 1528–1545, Sep. 2005.
- [18] F. Traverso, G. Vernazza, and A. Trucco, "Simulation of non-white and non-Gaussian underwater ambient noise," in *Proc. OCEANS Conf.*, Yeosu, Korea, May 2012, DOI: 10.1109/OCEANS-Yeosu.2012.6263385.
- [19] R. F. W. Coates, *Underwater Acoustic Systems*. New York, NY, USA: Macmillan, 1990, p. 92.
- [20] R. J. Webster, "A random noise generator for ocean noise statistics," *IEEE J. Ocean. Eng.*, vol. 19, no. 1, pp. 134–137, Jan. 1994.

- [21] P. A. van Walree and R. Otnes, "Ultrawideband underwater acoustic communication channels," *IEEE J. Ocean. Eng.*, 2013, DOI: 10.1109/JOE.2013.2253391.
- [22] M. Badiey, A. Song, and K. Smith, "Coherent reflection from surface gravity water waves during reciprocal acoustic transmissions," *JASA Exp. Lett.*, vol. 132, no. 4, pp. EL290–EL295, Sep. 2012.
- [23] K. McCoy, B. Tomasi, and G. Zappa, "JANUS: The genesis, propagation and use of an underwater standard," in *Proc. Eur. Conf. Underwater Acoust.*, Istanbul, Turkey, Jul. 2010.
- [24] P. van Walree, R. Otnes, G. Zappa, and J. Potter, "Comparison between JANUS and DSSS in Norwegian waters," in *Proc. Underwater Acoust. Meas. Conf.*, Kos, Greece, Jun. 2011, article 28.11.
- [25] G. Matz, A. F. Molisch, F. Hlawatsch, M. Steinbauer, and I. Gaspard, "On the systematic measurement errors of correlative mobile radio channel sounders," *IEEE Trans. Commun.*, vol. 50, no. 5, pp. 808–821, May 2002.
- [26] M. Stojanovic and L. Freitag, "Hypothesis-feedback equalization of direct-sequence spread spectrum underwater communications," in *Proc. MTS/IEEE OCEANS Conf.*, Providence, RI, USA, Sep. 2000, pp. 123–129.
- [27] P. A. van Walree and G. Leus, "Robust underwater telemetry with adaptive turbo multiband equalization," *IEEE J. Ocean. Eng.*, vol. 34, no. 4, pp. 645–655, Oct. 2009.
- [28] G. Leus and P. A. van Walree, "Multiband OFDM for covert acoustic communications," *IEEE J. Sel. Areas Commun.*, vol. 26, no. 9, pp. 1662–1673, Dec. 2008.
- [29] T. Xu, Z. Tang, G. Leus, and U. Mitra, "Multi-rate block transmissions over wideband multi-scale multi-lag channels," *IEEE Trans. Signal Process.*, vol. 61, no. 4, pp. 964–979, Feb. 15, 2013.
- [30] R. Otnes and T. H. Eggen, "Underwater acoustic communications: Long-term test of turbo equalization in shallow water," *IEEE J. Ocean. Eng.*, vol. 33, no. 3, pp. 321–334, Jul. 2008.



Roald Otnes (S'00–M'03) received the M.Sc. and Ph.D. degrees in telecommunications from the Norwegian University of Science and Technology, Trondheim, Norway, in 1998 and 2003, respectively.

Since 2003, he has been a Scientist at the Norwegian Defence Research Establishment (FFI), Horten, Norway. His current research interests include underwater acoustics and signal processing for communications as well as for detection.



Paul A. van Walree (M'08) received the M.Sc. and Ph.D. degrees in solid-state physics from Utrecht University, Utrecht, The Netherlands, in 1992 and 1997, respectively.

From 1998 to 2009, he was an Underwater Acoustician at The Netherlands Organisation for Applied Scientific Research (TNO), Delft, The Netherlands. In 2009, he started as a Scientist with the Maritime Systems Department, Norwegian Defence Research Establishment (FFI), Horten, Norway. His research interests include digital underwater communications, channel characterization and simulation, and acoustic signal processing.



Trond Jenserud received the M.Sc. degree in electrical engineering and the Ph.D. degree in telecommunications from the Norwegian Institute of Technology, Trondheim, Norway, in 1980 and 2001, respectively.

He is currently with the Norwegian Defence Research Establishment (FFI), Horten, Norway. His research interests include wave propagation, signal processing, and underwater communications.

Errata

Dimensions	Property	[13]	[6]	[1]	[14]	[12]	[21]	This paper
2	Spreading (or scattering) function			x				x
	Time-varying impulse response				x			x
1	Power delay profile		x				x	x
	Doppler power spectrum							x
	Correlation function			x				
	Level crossing rate				x	x	x	
	Average fade duration					x		
0	Delay spread							x
	Doppler spread		x					x
	Rice number		x					
	BER	x		x		x		x
	PER							x
	Output SINR			x				x

Erratum to “Validation of Replay-Based Underwater Acoustic Communication Channel Simulation”
[R. Otnes, P. A. van Walree, T. Jenserud, *IEEE J. Ocean. Eng.*, DOI: 10.1109/JOE.2013.2262743]

In the first row of Table I of [1], the following reference numbers should be fixed: reference [12] should be [13], reference [13] should

be [14], reference [11] should be [12], and reference [20] should be [21]. The correct Table I of [1] is included here.

REFERENCES

Manuscript received August 17, 2013. Date of publication September 06, 2013; date of current version October 09, 2013.
 Digital Object Identifier 10.1109/JOE.2013.2279511

- [1] R. Otnes, P. A. van Walree, and T. Jenserud, “Validation of replay-based underwater acoustic communication channel simulation,” *IEEE J. Ocean. Eng.*, 2013, DOI: 10.1109/JOE.2013.2262743.